

EuroSeries (ESR)

Features & Benefits

- Cowl & base moulded from recyclable polymeric material
- All sizes resistant to UV light
- Sizes 315 to 1000 dia are protected to IP54
- Optional backdraught shutters and bird guard (250-630mm)
- All models speed controllable
- Motor Insulation Class F, -40°C to +70°C operating temperature
- Reversible for supply or extract units
- Thermal overload for motor protection
- Performance tested to BS848 part 1 1980
- Designed for Data Centre and Warehouse cooling



A new range of extract axial blade industrial roof fans incorporating the new Euroseries ESP axial plate fan, featuring a single shot die cast aluminium blade & external rotor motor design.

Cowl and roof mounting base are moulded from specially formulated recyclable polymeric materials, which are high impact resistant and provide a rigid profile against strong winds and resistance to UV light. Standard colour BS00A05

EuroSeries ESR units shall be suitable for flat or inclined roofs (max. angle 30°) and are designed for either kerb or purlin box mounting.

The EuroSeries ESR range is available in eleven sizes with the extract performances up to 10.88m³/s, with pressure characteristics of up to 300Pa. All units are designed for & fully speed controllable.

Air Operated Shutters & Bird Guards

The shutters shall fit beneath the cowl using fitting provided. Shutters should not be used when the fan performance is below 30% of maximum and the hinge should point up the roof incline.

The standard shutters for sizes 800 & 1000mm must not be used with 4 & 6 pole unit. Please enquire for special metal shutters. Bird Guards are manufactured to fit neatly between the roof cowl and the base.

Impellers

All sizes shall be supplied with cast aluminium impellers, ensuring performance when working against outdoor conditions and abrasive airflow. All fans are reversible for Intake (-30% performance). Backdraught shutters should not be used when operated as an intake fan.

Motors

External rotor motors are specially designed and styled for this range of fan. Ball bearings shall be greased for life. Rotors are dynamically balanced to ISO 1940. Sizes 315-1000mm, motors are protected to

IP54, against dust and moisture complying with BS EN 60529:1992. They shall be ribbed aluminium body castings for efficient cooling. Motor insulation is Class 'F' (from -40°C to +70°C).

Electrical

Single phase 220-240V 50Hz. Capacitor start and run. Three phase 380-415V 50Hz. An IP54 terminal box shall be supplied with most models with 20mm and PGII entry. All motors shall be fitted with thermal overload protection which should be wired into all controller circuits and into starter contactors. Models are available with either 2, 4, 6 & 8 pole motors.

Terminal Box

Are to IP54, as standard, protected against dust water from any angle allowing outside applications.

Performance

The fan performance, shall be in accordance with tests to BS848 Part 1 1980.

Sound Levels

Fan sound levels, measured in a reverberant chamber in accordance with BS848 Part 2 1985. Published dB(A) figures are free field sound pressure levels at 3m with spherical propagation at a reference level of 2 x 10⁻⁵ Pa (20 micro-Pascal). The sound power level spectra figures are dB with reference level of 10-12 Watts (1 pico-watt). To ensure minimum noise levels during speed control, an auto transformer speed control is recommended.

Fan Dimensions (mm)

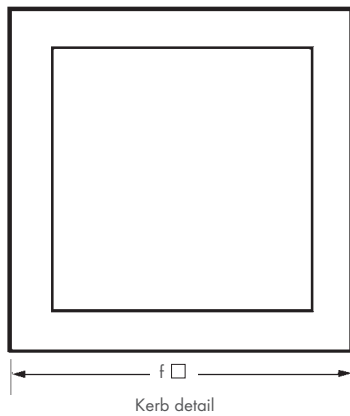
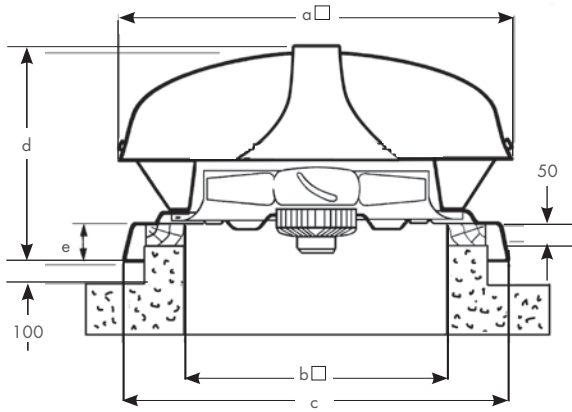

Size	a	b	c	d	e	f	kg Max
250	700	475	737	411	97	675	13.25
315	700	475	737	411	97	675	16.3
355	700	475	737	411	97	675	16.3
400	800	575	830	466	97	775	18.4
450	800	575	830	466	97	775	20.3
500	950	715	1000	579	100	915	35.5
560	950	715	1000	579	100	915	35.5
630	1230	840	1100	731	105	1040	62
710	1230	840	1100	731	105	1040	62
800	1420	870	1190	731	105	1070	78
1000	1680	1070	1455	795	131	1270	134

Purlin Box (mm)

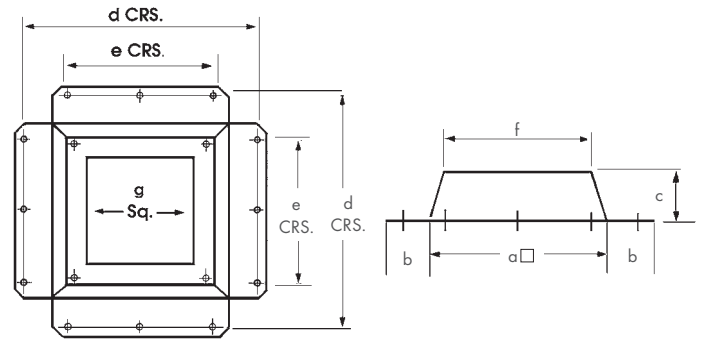

Size	a	b	c	d	e	f	g
250	625	90	240	765	400	590	460
315	625	90	240	765	400	590	460
355	625	90	240	765	400	590	460
400	725	90	240	865	500	705	565
450	725	90	240	865	500	705	565
500	890	70	250	990	650	850	640
560	890	70	250	990	650	870	700
630	1030	75	250	1140	760	985	775
710	1030	75	250	1140	760	985	840
800	980	37	267	1016	406	980	880
1000	1180	76	279	1294	508	1180	1080

Performance Curves

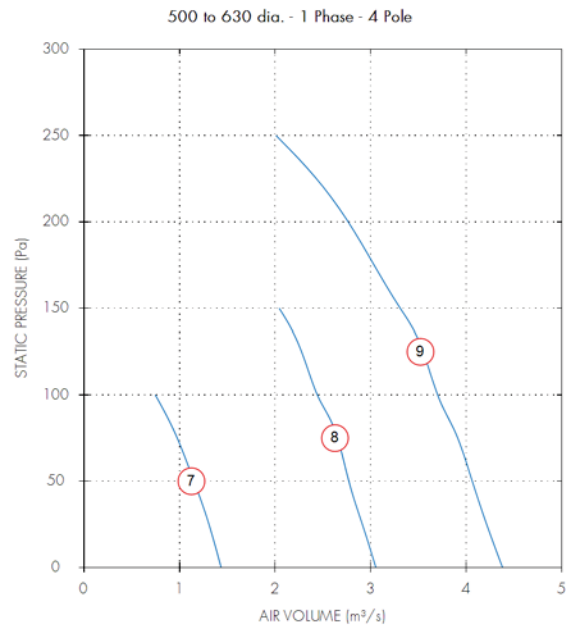
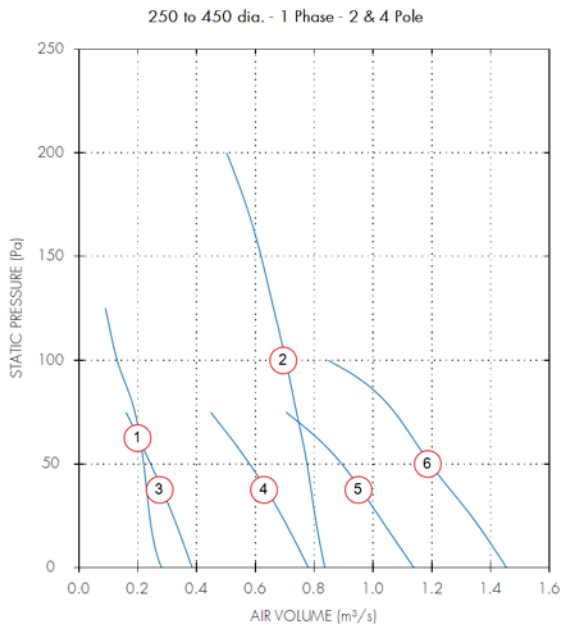

Performance Guide

Dia.	Motor Phase	Stock Ref	Poles	r.p.m	IP Rating	Curve Ref.	m ³ /s @ Pa					Motor kW	S.C. Amps	F.L.C Amps	dBA @ 3m
							0	50	100	150	200				
250	1	ESR25012	2	2440	IP44	1	0.28	0.22	0.13			0.12	1.15	0.54	59
315	1	ESR31512	2	2690	IP54	2	0.84	0.78	0.7	0.62	0.5	0.56	72	2.4	64
315	1	ESR31514	4	1300	IP54	3	0.38	0.24				0.15	1.38	0.7	50
355	1	ESR35514	4	1330	IP54	4	0.78	0.58				0.19	1.45	0.84	53
400	1	ESR40014	4	1350	IP54	5	1.14	0.89				0.29	2.4	1.45	56
450	1	ESR45014	4	1370	IP54	6	1.45	1.19	0.85			0.36	3.6	1.6	61
500	1	ESR50014	4	1290	IP54	7	1.43	1.15	0.75			0.51	4.3	2.3	55
560	1	ESR56014	4	1320	IP54	8	3.05	2.77	2.44	2.04		1.35	21	6	63
630	1	ESR63014	4	1320	IP54	9	4.38	4.06	3.7	3.31	2.76	2.2	28	9.9	70

ESR25012, ESR31512 & ESR25014 not suitable for reverse airflow.

Sound Power Level Spectra dB (ref 10⁻¹² Watts)

Dia.	Motor Phase	Stock Ref	Poles	Spectrum	dB								dBA @ 3m
					63	125	250	500	1k	2k	4k	8k	
250	1	ESR25012	2	Inlet	69	70	76	76	70	70	67	59	57
250	1	ESR25012	2	Outlet	69	70	76	76	70	70	67	59	57
315	1	ESR31512	2	Inlet	69	73	79	74	74	76	73	66	61
315	1	ESR31512	2	Outlet	69	73	79	74	74	76	73	66	61
315	1	ESR31514	4	Inlet	70	68	66	61	60	62	58	51	47
315	1	ESR31514	4	Outlet	70	68	66	61	60	62	58	51	47
355	1	ESR35514	4	Inlet	65	70	67	65	64	64	62	55	50
355	1	ESR35514	4	Outlet	65	70	67	65	64	64	62	55	50
400	1	ESR40014	4	Inlet	70	72	67	66	65	65	64	56	51
400	1	ESR40014	4	Outlet	70	72	67	66	65	65	64	56	51
450	1	ESR45014	4	Inlet	69	76	73	72	70	71	70	62	57
450	1	ESR45014	4	Outlet	69	76	73	72	70	71	70	62	57
500	1	ESR50014	4	Inlet	65	75	69	70	70	71	69	62	56
500	1	ESR50014	4	Outlet	65	75	69	70	70	71	69	62	56
560	1	ESR56014	4	Inlet	100	90	89	84	82	79	75	68	67
560	1	ESR56014	4	Outlet	100	90	89	84	82	79	75	68	67
630	1	ESR63014	4	Inlet	82	86	79	79	80	78	75	70	64
630	1	ESR63014	4	Outlet	82	86	79	79	80	78	75	70	64

Performance Curves

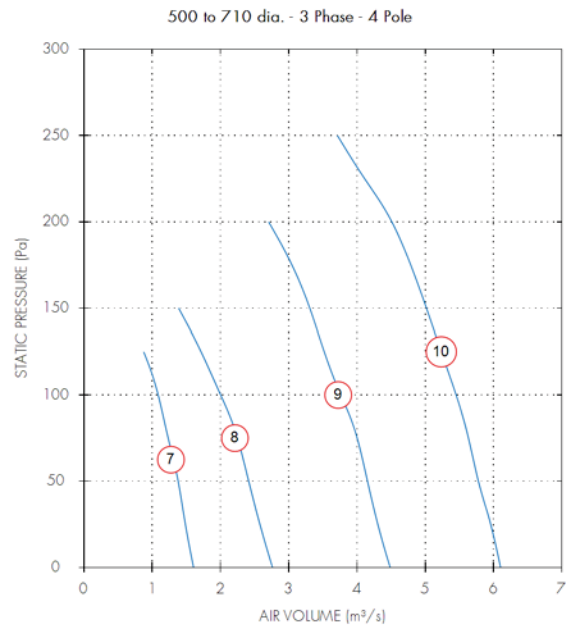
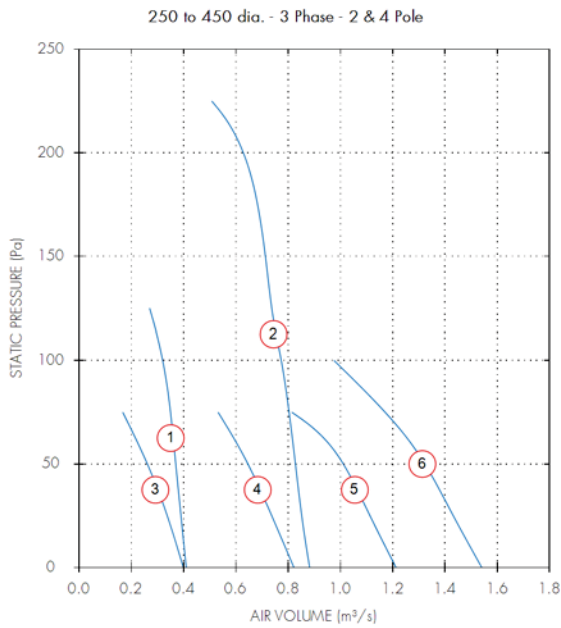

Performance Guide

Dia.	Motor Phase	Stock Ref	Poles	r.p.m	IP Rating	Curve Ref.	m³/s @ Pa						Motor kW	S.C. Amps	F.L.C Amps	dBA @ 3m
							0	50	100	150	200	250				
250	3	ESR25032	2	2700	IP44	1	0.41	0.37	0.32				0.2	3.5	0.87	61
315	3	ESR31532	2	2800	IP54	2	0.88	0.83	0.77	0.71	0.63		0.48	5	0.9	60
315	3	ESR31534	4	1390	IP54	3	0.4	0.26					0.11	2.1	0.27	46
355	3	ESR35534	4	1370	IP54	4	0.82	0.65					0.17	1.35	0.37	49
400	3	ESR40034	4	1350	IP54	5	1.21	1.01					0.26	2.1	0.56	51
450	3	ESR45034	4	1380	IP54	6	1.54	1.32	0.98				0.36	2.6	0.8	56
500	3	ESR50034	4	1380	IP54	7	1.6	1.38	1.09				0.55	3.7	1.05	58
560	3	ESR56034	4	1220	IP54	8	2.76	2.41	2	1.39			1.25	7.7	2.2	70
630	3	ESR63034	4	1360	IP54	9	4.49	4.15	3.76	3.31	2.7		1.9	14	3.2	64
710	3	ESR71034	4	1290	IP54	10	6.1	5.78	5.45	5.02	4.51	3.71	2.9	19	5.3	72

Sound Power Level Spectra dB (ref 10⁻¹² Watts)

Dia.	Motor Phase	Stock Ref	Poles	Spectrum	dB												dBA @ 3m
					63	125	250	500	1k	2k	4k	8k					
250	3	ESR25032	2	Inlet	69	70	75	79	74	70	66	60	59				
250	3	ESR25032	2	Outlet	69	70	75	79	74	70	66	60	59				
315	3	ESR31532	2	Inlet	71	72	83	80	78	79	75	67	64				
315	3	ESR31532	2	Outlet	71	72	83	80	78	79	75	67	64				
315	3	ESR31534	4	Inlet	64	67	69	63	62	60	58	53	47				
315	3	ESR31534	4	Outlet	64	67	69	63	62	60	58	53	47				
355	3	ESR35534	4	Inlet	58	73	63	64	64	65	64	58	50				
355	3	ESR35534	4	Outlet	58	73	63	64	64	65	64	58	50				
400	3	ESR40034	4	Inlet	62	73	65	65	67	69	67	60	53				
400	3	ESR40034	4	Outlet	62	73	65	65	67	69	67	60	53				
450	3	ESR45034	4	Inlet	65	82	75	76	73	72	69	62	58				
450	3	ESR45034	4	Outlet	65	82	75	76	73	72	69	62	58				
500	3	ESR50034	4	Inlet	67	71	69	72	70	71	68	61	56				
500	3	ESR50034	4	Outlet	67	71	69	72	70	71	68	61	56				
560	3	ESR56034	4	Inlet	85	79	77	76	76	75	72	66	61				
560	3	ESR56034	4	Outlet	85	79	77	76	76	75	72	66	61				
630	3	ESR63034	4	Inlet	71	88	82	83	82	81	78	72	67				
630	3	ESR63034	4	Outlet	71	88	82	83	82	81	78	72	67				
710	3	ESR71034	4	Inlet	80	87	86	88	89	86	83	79	72				
710	3	ESR71034	4	Outlet	80	87	86	88	89	86	83	79	72				

Performance Curves

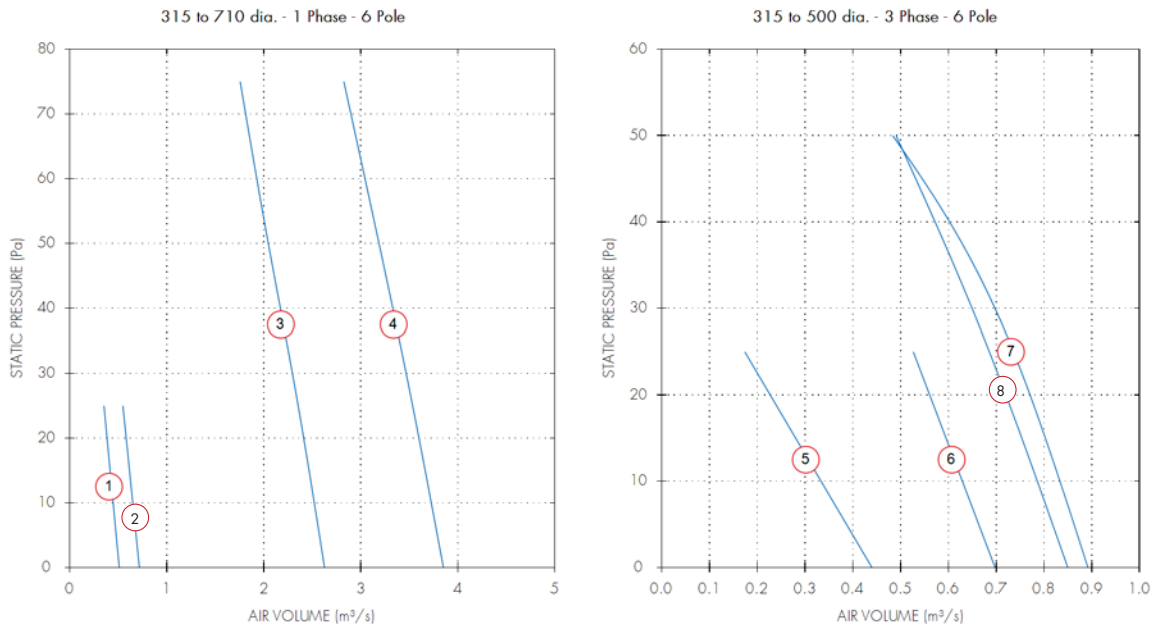

Performance Guide

Dia.	Motor Phase	Stock Ref	Poles	r.p.m	IP Rating	Curve Ref.	m³/s @ Pa				Motor kW	S.C. Amps	F.L.C Amps	dBA @ 3m
							0	25	50	75				
355	1	ESR35516	6	950	IP54	1	0.51	0.35			0.09	1.2	0.46	44
400	1	ESR40016	6	940	IP54	2	0.72	0.55			0.13	1.4	0.6	45
630	1	ESR63016	6	880	IP54	3	2.63	2.35	2.05	1.76	0.6	5.3	2.7	57
710	1	ESR71016	6	850	IP54	4	3.85	3.53	3.19	2.82	0.89	8	4.1	60
355	3	ESR35536	6	910	IP54	5	0.44	0.17			0.09	0.5	0.25	45
400	3	ESR40036	6	920	IP54	6	0.7	0.53			0.11	0.9	0.28	50
450	3	ESR45036	6	890	IP54	7	0.89	0.74	0.48		0.12	1	0.28	51
500	3	ESR50036	6	900	IP54	8	0.85	0.69	0.49		0.23	1.5	0.56	56

Sound Power Level Spectra dB (ref 10⁻¹² Watts)

Dia.	Motor Phase	Stock Ref	Poles	Spectrum	dB								dBA @ 3m
					63	125	250	500	1k	2k	4k	8k	
355	1	ESR35516	6	Inlet	59	59	60	57	56	57	55	46	42
355	1	ESR35516	6	Outlet	59	59	60	57	56	57	55	46	42
400	1	ESR40016	6	Inlet	76	74	70	65	63	58	52	44	48
400	1	ESR40016	6	Outlet	76	74	70	65	63	58	52	44	48
630	1	ESR63016	6	Inlet	88	85	81	77	76	70	64	58	60
630	1	ESR63016	6	Outlet	88	85	81	77	76	70	64	58	60
710	1	ESR71016	6	Inlet	83	83	84	80	78	74	70	72	63
710	1	ESR71016	6	Outlet	83	83	84	80	78	74	70	72	63
355	3	ESR35536	6	Inlet	60	61	60	56	56	56	54	46	42
355	3	ESR35536	6	Outlet	60	61	60	56	56	56	54	46	42
400	3	ESR40036	6	Inlet	60	60	62	59	60	60	58	50	45
400	3	ESR40036	6	Outlet	60	60	62	59	60	60	58	50	45
450	3	ESR45036	6	Inlet	63	72	66	63	63	62	59	48	48
450	3	ESR45036	6	Outlet	63	72	66	63	63	62	59	48	48
500	3	ESR50036	6	Inlet	78	73	68	67	68	66	59	51	52
500	3	ESR50036	6	Outlet	78	73	68	67	68	66	59	51	52

Performance Curves

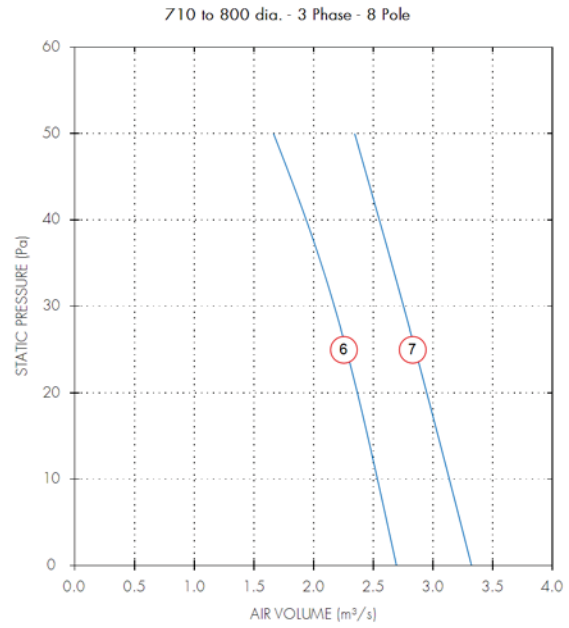
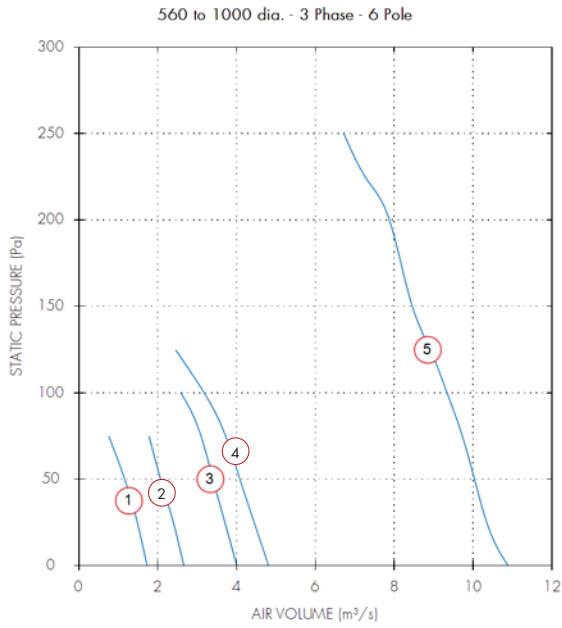

Performance Guide

Dia.	Motor Phase	Stock Ref	Poles	r.p.m	IP Rating	Curve Ref.	m ³ /s @ Pa							Motor kW	S.C. Amps	F.L.C Amps	dBA @ 3m	
							0	50	100	150	200	250						
560	3	ESR56036	6	860	IP54	1	1.72	1.16							0.36	1.75	0.74	56
630	3	ESR63036	6	890	IP54	2	2.66	2.07							0.59	3.6	1.3	59
710	3	ESR71036	6	860	IP54	3	4	3.4	2.58						1.1	7.7	2.2	62
800	3	ESR80036	6	900	IP54	4	4.81	4.08	3.18						1.4	7.7	2.2	64
1000	3	ESR100036	6	935	IP54	5	10.88	10.04	9.34	8.45	7.87	6.72			5.5	67	10.5	77
710	3	ESR71038	8	630	IP54	6	2.69	1.66							0.43	3.3	1.1	55
800	3	ESR80038	8	670	IP54	7	3.32	2.34							0.69	5	1.75	58

Sound Power Level Spectra dB (ref 10⁻¹² Watts)

Dia.	Motor Phase	Stock Ref	Poles	Spectrum	dB								dBA @ 3m
					63	125	250	500	1k	2k	4k	8k	
560	3	ESR56036	6	Inlet	67	72	72	68	68	68	65	57	53
560	3	ESR56036	6	Outlet	67	72	72	68	68	68	65	57	53
630	3	ESR63036	6	Inlet	67	78	76	74	73	72	77	59	60
630	3	ESR63036	6	Outlet	67	78	76	74	73	72	77	59	60
710	3	ESR71036	6	Inlet	80	77	78	75	76	75	70	64	60
710	3	ESR71036	6	Outlet	80	77	78	75	76	75	70	64	60
800	3	ESR80036	6	Inlet	73	83	79	75	75	77	74	64	62
800	3	ESR80036	6	Outlet	73	83	79	75	75	77	74	64	62
1000	3	ESR100036	6	Inlet	80	90	90	91	90	86	85	79	74
1000	3	ESR100036	6	Outlet	80	90	90	91	90	86	85	79	74
710	3	ESR71038	8	Inlet	75	75	73	71	72	70	64	57	56
710	3	ESR71038	8	Outlet	75	75	73	71	72	70	64	57	56
800	3	ESR80038	8	Inlet	75	75	73	71	72	70	64	57	56
800	3	ESR80038	8	Outlet	75	75	73	71	72	70	64	57	56

Models & Accessories

Fan Stock Ref	Speed Controllers				Overload Stock Ref	Fan Stock Ref
	Electronic	Auto	Starter			
	1ph Stock Ref	Transfor 1ph Stock Ref	1 phase Ref			
1 Phase - 2 Pole					3 Phase - 2 Pole	
ESR25012	SP5001	SPM5020	444744	444699	ESR25032	
ESR31512	SP5025	SPM5035	444744	444701	ESR31532	
1 Phase - 4 Pole					3 Phase - 4 Pole	
ESR25014	SP5001	SPM5020	444744	444696		
ESR31514	SP5001	SPM5020	444744	444699	ESR31534	
ESR35514	SP5001	SPM5020	444744	444699	ESR35534	
ESR40014	SP5025	SPM5020	444744	444701	ESR40034	
ESR45014	SP5025	SPM5020	444744	444701	ESR45034	
ESR50014	SP5025	SPM5035	444744	444702	ESR50034	
ESR56014	SP5010	SPM5075	444744	444704	ESR56034	
ESR63014		SPM5140	444744	444706	ESR63034	
					ESR71034	
1 Phase - 6 Pole					3 Phase - 6 Pole	
ESR35516	SP5001	SPM5020	444744	444698	ESR35536	
ESR40016	SP5001	SPM5020	444744	444699	ESR40036	
					ESR50036	
					ESR56036	
ESR63016	SP5050	SPM5035	444744	444702	ESR63036	
ESR71016	SP5050	SPM5060	444744	444703	ESR71036	
					ESR80036	
					ESR100036*	
					3 Phase - 6 Pole	
					ESR63038	
					ESR71038	
					ESR80038	

*Not suitable for voltage speed control. Inverter speed control with sine filters only.

Model Ref	Roof Cowl Assembly	Drop in Curb Attenuator		
	ONLY (No Fan)	(600mm)	(900mm)	(1200mm)
	Stock Ref	Stock Ref	Stock Ref	Stock Ref
ESR250	-	RAZ300600	RAZ300900	-
ESR315 & 355	RCZ300	RAZ300600	RAZ300900	RAZ3001200
ESR400 & 450	RCZ400	RAZ400600	RAZ400900	RAZ4001200
ESR500 & 560	RCZ500	RAZ500600	RAZ500900	RAZ5001200
ESR630	RCZ630	RAZ600600	RAZ600900	RAZ6001200
ESR710	RCZ630	RAZ600600	RAZ600900	RAZ6001200
ESR800	RCZ800			
ESR1000	RCZ1000			

Speed Controllers

Auto Transfor 3ph Stock Ref	Starter 3 phase Stock Ref	Overload Stock Ref	Shutters Stock Ref	Birdguard Stock Ref	Adaptor Units (Purlin Box) Stock Ref
RDTK10	444747	444699	RSZ300	BGZ300	PBZ300
RDTK10	444747	444700	RSZ300	BGZ300	PBZ300
			RSZ300	BGZ300	PBZ300
RDTK10	444747	444697	RSZ300	BGZ300	PBZ300
RDTK10	444747	444698	RSZ300	BGZ300	PBZ300
RDTK10	444747	444699	RSZ400	BGZ400	PBZ400
RDTK10	444747	444699	RSZ400	BGZ400	PBZ400
RDTK20	444747	444700	RSZ500	BGZ500	PBZ500
RDTK40	444747	444701	RSZ500	BGZ500	PBZ560
RDTK40	444747	444702	RSZ630	BGZ630	PBZ630
RDTK70	444747	444703	RSZ630	BGZ630	PBZ710
RDTK10	444747	444697	RSZ300	BGZ300	PBZ300
RDTK10	444747	444697	RSZ400	BGZ400	PBZ400
RDTK10	444747	444699	RSZ500	BGZ500	PBZ500
RDTK10	444747	444699	RSZ500	BGZ500	PBZ560
RDTK20	444747	444700	RSZ630	BGZ630	PBZ630
RDTK40	444747	444702	RSZ630	BGZ630	PBZ710
RDTK40	444747	444702	-	INCL	PBZ800
-	444748	444706	-	INCL	PBZ1000
RDTK10	444747	444699	RSZ630	BGZ630	PBZ630
RDTK20	444747	444700	RSZ630	BGZ630	PBZ710
RDTK20	444747	444701	-	INCL	PBZ800

Note:

- The Standard roof cowl colour is BS 00A 05 (Goose Wing Grey) for all special B.S. or RAL colours contact Vent-Axia.
- When speed control is required a 5 step auto transformer speed controller is recommended, to ensure low noise levels.
- All 3 phase models are suitable for frequency inverter speed control.
- Vent-Axia only recommend using Inverters with integral Sine Filters for reliable operation.