

# Lo-Carbon Sentinel Kinetic FH

- Acoustic Enclosure option for reduced breakout noise
- Acoustic Top Box option for reduced in-duct noise
- Lightweight for easier installation
- Horizontal duct option for space-saving installations
- Integrated digital controller for simple and accurate commissioning
- Plug and play controls; Humidistat, Wireless Remote
- BMS connectivity
- LS inputs (Light Switch)
- Volt-free inputs
- Self diagnosis for simplified fault finding
- Adjustable delay On/delay Off timer



## Easy Installation

The Sentinel Kinetic models can be mounted vertically in a roof space or in an appropriate cupboard within the dwelling. When mounted in an unheated area the ducting and unit must be insulated in accordance with the Domestic Ventilation Compliance Guide. Ducting can be attached to the unit horizontally, vertically or both.

For scenarios where noise is a critical issue, an Acoustic Enclosure is available to reduce breakout noise and the Acoustic Top Box will reduce in-duct noise at key frequencies.

**Left (L) or right (R) hand installation.** Left hand and right hand units are available.

## Spigot Options

The combination of spigot options allows installation in confined locations. If vertical and horizontal connection is required on the same outlet/inlet, additional spigots can be supplied.

The condensate drain can be taken out through the back, side or bottom of the unit. Using the fittings supplied, the final condensate connection is made outside the unit and can be completed after installation.

## Integral Humidity Sensor

The integral humidity sensor increases speed in proportion to relative humidity levels, saving energy and reducing noise. The sensor also reacts to small but rapid increases in humidity, even if the normal trigger threshold is not reached. This unique feature ensures adequate ventilation, even for the smallest wet room. The night time relative humidity setback feature suppresses nuisance tripping as humidity gradually increases with falling temperature.

## Model

Model	Stock Ref
Sentinel Kinetic FH Right	408167
Sentinel Kinetic FH Right with Acoustic Top Box & Enclosure	479532
Sentinel Kinetic FH Right with Acoustic Top Box	479531
Sentinel Kinetic FH Right with Acoustic Enclosure	479530
Sentinel Kinetic FH Left	408169
Sentinel Kinetic FH Left with Acoustic Top Box & Enclosure	479535
Sentinel Kinetic FH Left with Acoustic Top Box	479534
Sentinel Kinetic FH Left with Acoustic Enclosure	479533

(FH comes with summer bypass & humidity sensor)

## Accessories

Model	Stock Ref
Wired Remote Controller	443283
Wireless Enable Kit	441865
Wireless Transmitter Controller	437827
LED alarm with 15m cable	448356
ISO 45% Coarse (G3) Filter 2pk	409764
ISO ePM10 50% (M5) Filter 2pk	472153
Anti Vibration Mounts	68MP033G
Acoustic Purge Fan	477988

## SAP PCDB performance

	SAP 2009		SAP 2012	
	Thermal Efficiency %	SFP (W/l/s)	Thermal Efficiency %	SFP (W/l/s)
K+1	90	0.53	89	0.53
K+2	89	0.51	88	0.60
K+3	88	0.56	86	0.71
K+4	87	0.65	84	0.88
K+5	85	0.75	84	1.07

## SEC Class

Model	SEC Class
Kinetic FH/FHL	A+

## Dimensions (mm)

Unit

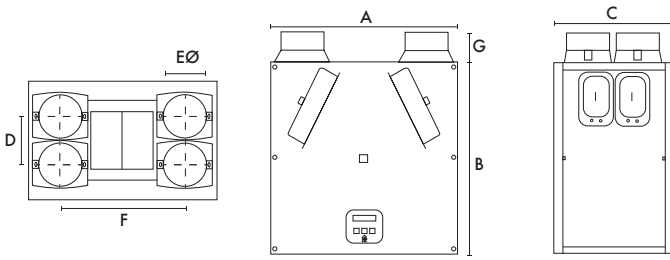

A	B	C	D	EØ	F	G
555	550	350	140	125	360	90

Weight: 18kg

## Acoustic Solution

Top

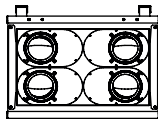

Front

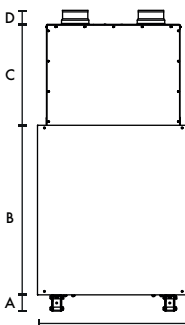

Side

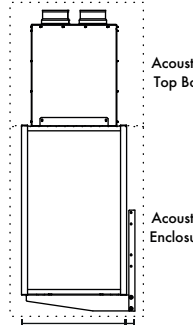

Acoustic Acoustic

Top Box Enclosure

A	B	C	D	E	F	G	kg	kg	Spigot
80	633	501	75	626	447	45	11	19	125

## Performance

Fan speeds are fully adjustable within the performance range.

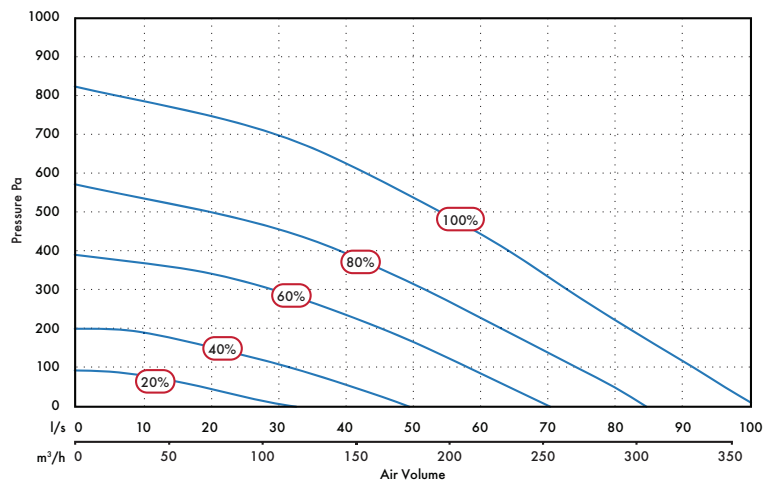

## Sound Data (Unit only)

Port	Octave band, Hz, dB SWL										SPL dB(A) @ 3m
	63	125	250	500	1k	2k	4k	8k	LwA		
20%	Supply	66.2	67.2	54.3	48.0	42.1	33.3	22.5	25.6	53.9	36.4
	Extract	57.7	56.6	47.2	43.5	35.3	24.1	19.6	25.7	45.7	28.2
	Breakout	41.2	47.0	41.7	39.5	34.6	30.4	22.5	25.7	41.0	20.5
40%	Supply	68.9	66.4	68.8	57.8	52.1	44.9	35.3	28.8	62.4	44.9
	Extract	66.8	56.1	56.9	52.1	44.7	34.6	23.8	25.8	53.2	35.7
	Breakout	47.3	47.5	56.4	48.0	44.0	39.6	32.8	29.1	51.0	30.5
60%	Supply	72.8	72.5	82.2	64.4	59.9	53.8	46.2	40.3	74.4	56.9
	Extract	67.3	61.9	66.5	58.9	52.2	42.7	32.6	27.6	61.1	43.6
	Breakout	53.9	53.2	65.9	55.8	52.2	48.2	42.5	39.3	61.0	40.5
80%	Supply	85.0	75.3	72.5	77.9	65.3	58.8	52.1	47.4	76.0	58.5
	Extract	83.5	65.2	65.0	65.5	57.0	47.7	37.9	31.3	65.5	48.0
	Breakout	56.4	56.4	60.4	69.8	56.7	53.2	47.8	42.0	66.5	46.0
100%	Supply	95.5	77.7	74.0	80.4	68.7	62.9	56.9	52.4	79.1	61.6
	Extract	83.3	68.3	66.9	71.2	60.7	51.4	42.4	36.1	69.7	52.2
	Breakout	62.1	59.7	62.9	70.0	61.0	57.3	52.3	46.9	68.0	47.5

## Sound Data (Unit with Acoustic Solution)

Port	Octave band, Hz, dB SWL										SPL dB(A) @ 3m
	63	125	250	500	1k	2k	4k	8k	LwA		
20%	Supply	58.2	62.1	46.8	33.7	21.1	14.1	18.2	24.1	47.5	30.0
	Extract	55.9	48.3	37.1	26.8	17.7	14.5	18.0	23.7	36.2	18.7
	Breakout	41.8	45.1	38.7	29.1	18.4	13.7	17.8	23.5	34.7	14.2
40%	Supply	66.5	59.3	59.3	43.5	30.5	15.9	17.9	23.5	52.1	34.6
	Extract	57.4	49.7	50.9	36.2	23.5	15.0	18.1	23.7	43.5	26.0
	Breakout	47.1	47.6	49.8	38.4	30.2	21.0	18.5	23.6	42.6	22.1
60%	Supply	69.5	66.0	66.5	50.7	40.2	20.6	18.8	24.2	59.3	41.8
	Extract	62.4	57.1	53.7	43.2	32.5	19.5	18.5	23.8	48.0	30.5
	Breakout	51.8	54.5	54.4	45.2	38.9	32.1	24.4	24.0	49.0	28.5
80%	Supply	78.5	68.9	63.3	61.3	45.1	25.7	20.7	25.8	61.0	43.5
	Extract	74.2	59.8	55.8	49.9	37.8	24.4	20.5	23.9	52.4	34.9
	Breakout	57.6	57.6	56.4	52.0	43.7	38.0	31.6	25.6	52.2	31.7
100%	Supply	75.7	70.8	67.1	65.7	48.2	30.4	23.6	27.8	64.6	47.1
	Extract	75.6	62.9	59.5	53.1	42.2	29.4	24.3	24.7	55.7	38.2
	Breakout	64.3	59.8	60.3	56.8	47.1	42.2	36.9	28.8	56.4	35.9

Tested according to BS EN 13141-7:2010. Breakout quoted spherical. Supply and Extract quoted hemispherical. For in-duct data, end reflections are added based on the spigot size of the unit.

## Consultant's Specification

### Operation

The supply and extract ventilation unit shall be a Sentinel Kinetic as manufactured by Vent-Axia and shall be sized as indicated on the drawings and shall be in accordance with the particular specification.

Supply air to the room shall be pre-heated by the extract air via the integrated composite plastic counterflow heat recovery cell. The Sentinel Kinetic shall automatically vary the ventilation rate via EC/DC motors, as it receives signals from one of the optional interconnected sensors. When a signal is received, the fans shall either vary their speed proportionally or on a trickle and boost principle.

The unit shall have the facility to commission the supply and extract fans individually via in-built minimum and maximum speed adjustment, or alternative wired remote control unit. The fans themselves shall have independent, infinitely variable speed control.

### Unit Specification

The unit shall be manufactured with an ABS outer case construction, and incorporate a reversible core to allow for left or right hand mounting.

The unit shall have a high efficiency composite plastic counterflow heat exchanger, supply and extract filters, automatic summer bypass, integral minimum and maximum infinitely variable speed controls with fascia mounted failure indication. The unit shall have low energy, high efficiency EC/DC fan/motor assemblies with sealed for life bearings. The impellers shall be high efficiency backward curved centrifugal type.

The unit shall have a heat exchanger cell with a thermal efficiency of up to 90% when tested to EN 308. This shall be protected by ISO 45% Coarse (G3) grade synthetic filters on supply and extract. Complete with a condensate drip tray and drain connection.

To reduce breakout noise, the MVHR unit shall be provided with an Acoustic Enclosure of steel construction lined with class 'O' acoustic foam. To reduce in-duct noise, the top of the MVHR shall be fitted with an Acoustic Top Box to provide attenuation to the 4 ducts of the unit. This Acoustic Top Box shall be of steel construction lined with acoustic class 'O' foam with the MVHR spigots linked to the Top Box via 4 separate attenuated ducts. The acoustic enclosure and top box shall each be independently tested for noise to BS EN 13141-7.

The unit shall be constructed with a removable Core allowing full maintenance access. The removable Core shall provide access to the following:

- ✓ Supply and extract filter
- ✓ Heat exchanger
- ✓ Access to the electrical connections

Access shall be provided for wiring termination and setup/commissioning. The backlit LCD user interface therein shall be removable for remote mounting if required.

Units shall be as manufactured by Vent-Axia Ltd.

Acoustically tested to BS EN 13141-7

### Standard Controls

All Sentinel Kinetic units shall incorporate the following functions integrally mounted, pre-wired and factory fitted by the manufacturer:

- ✓ Integral infinitely variable fan speed control on supply and extract
- ✓ Integral min/max ventilation control/set point
- ✓ Integral BMS interfaces – control and status indication

- ✓ Heating interlocks
  - ✓ 0-10V proportional speed adjustment
  - ✓ Volt free contacts
  - ✓ 24V sensor supply
  - ✓ Integral on/off or trickle boost function from remote switch e.g. PIR occupancy detector
  - ✓ The unit shall be controlled by the 'Sentinel' control devices (enablers and sensors) as detailed in the schedule or on the drawings
  - ✓ Fully automatic summer bypass
  - ✓ Switched Live input with adjustable 'delay-on' feature
  - ✓ Fan failure or component failure indicated via individual fault code display
  - ✓ Running time counter
  - ✓ Control panel PIN number lock
  - ✓ Automatic frost protection effective to -20°C
  - ✓ Tool free filter access
  - ✓ The unit shall incorporate ('H' models) an integral humidity sensor with the following features:
    - Ambient Response; Raises the humidity trigger point as dwelling temperature reduces
    - Rapid Response; Monitors the rate of change in humidity and triggers increased airflow even if the humidity trigger threshold is not reached
    - Proportional Response; Incrementally increases the fan speed to reduce noise and reduce energy consumption
-

## Airflow Direction

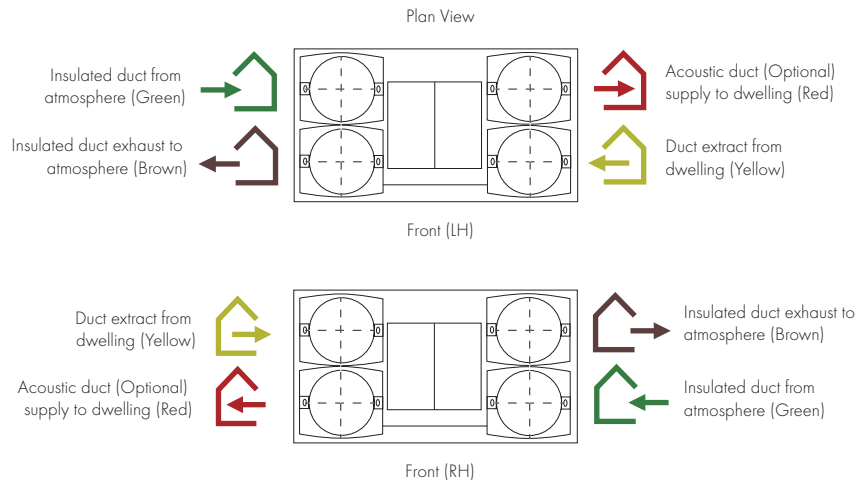

## Electrical Connection

Please note: Electrical connection should be carried out by an appropriately qualified person and in accordance with current wiring regulations.

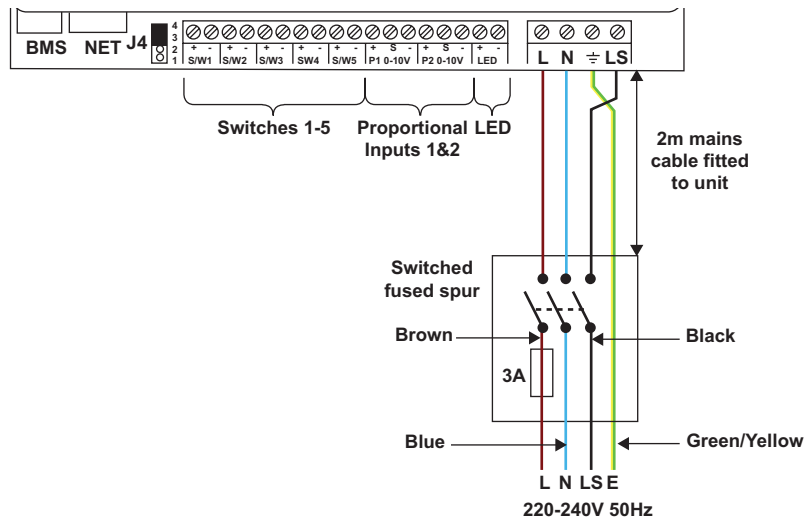

## Trickle to Boost by Trickle/Boost Switch

